

# Introduction to Fusion

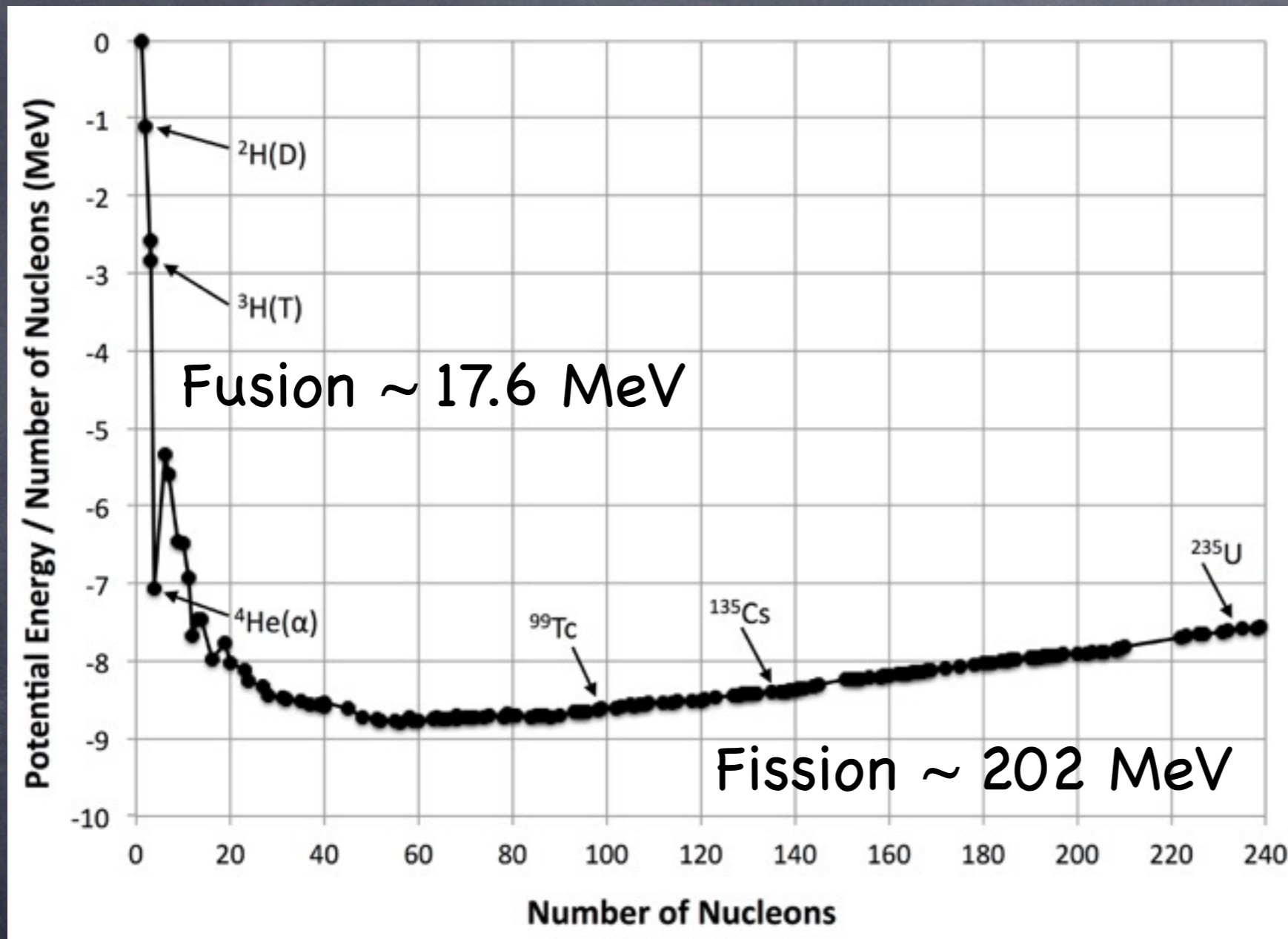

Lise Meitner

Mass-energy ( $mc^2$ ) of nuclei minus total  $mc^2$  of protons and neutrons from which they are formed ( $\sim 940$  MeV each), divided by the number of nucleons

# Fission Runs on a Chain Reaction

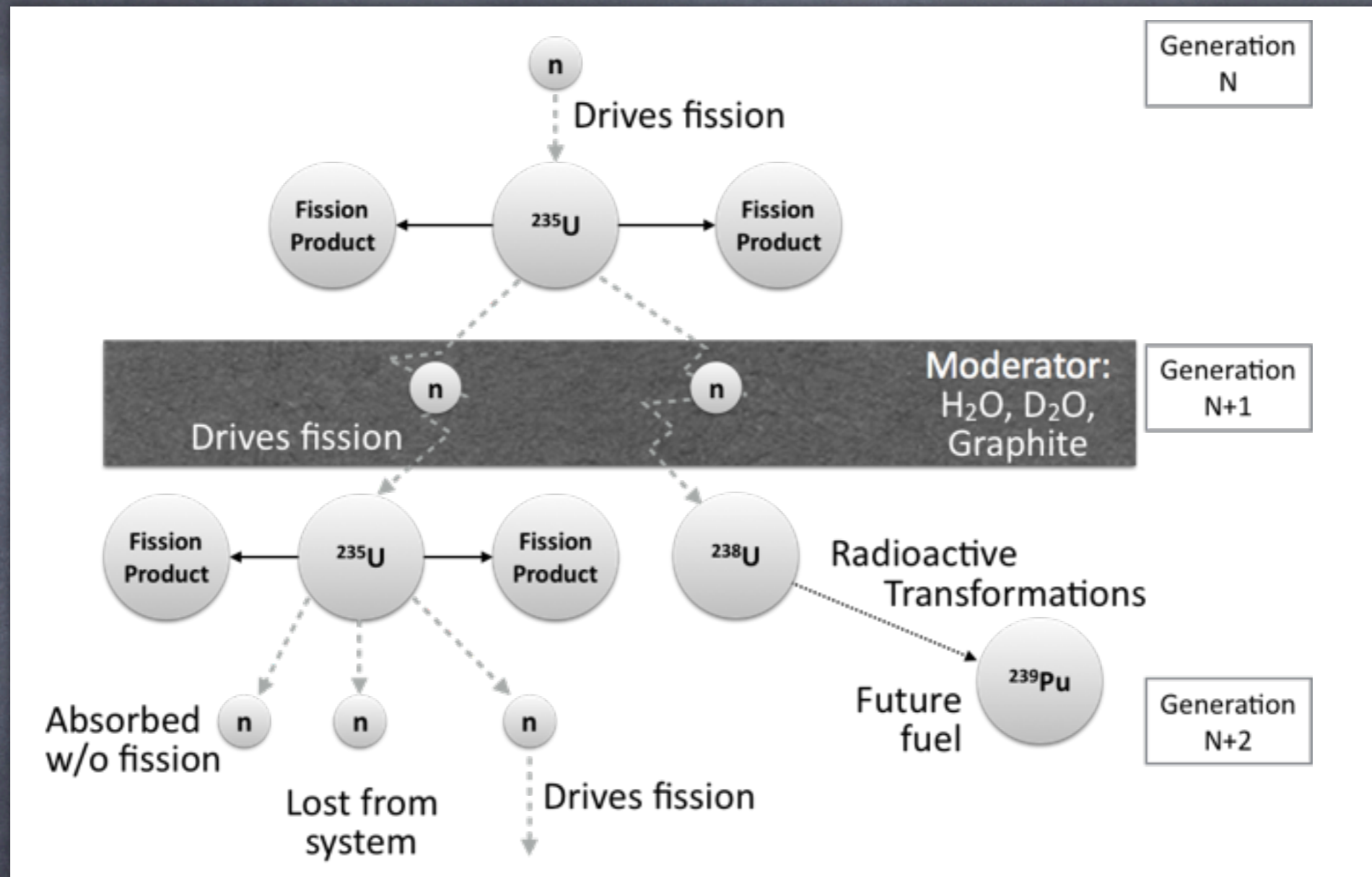

1 generation is about 50  $\mu\text{sec}$  in a light water reactor.

$N_{\text{Doubling}} \approx 70 / \% \text{ increase per generation}$

# Safety - Prompt Criticality: Chernobyl

- The controllability of fission systems depends on “delayed neutrons”
  - $\approx 15$  second delay; 0.65% of total for uranium, 0.21% for plutonium

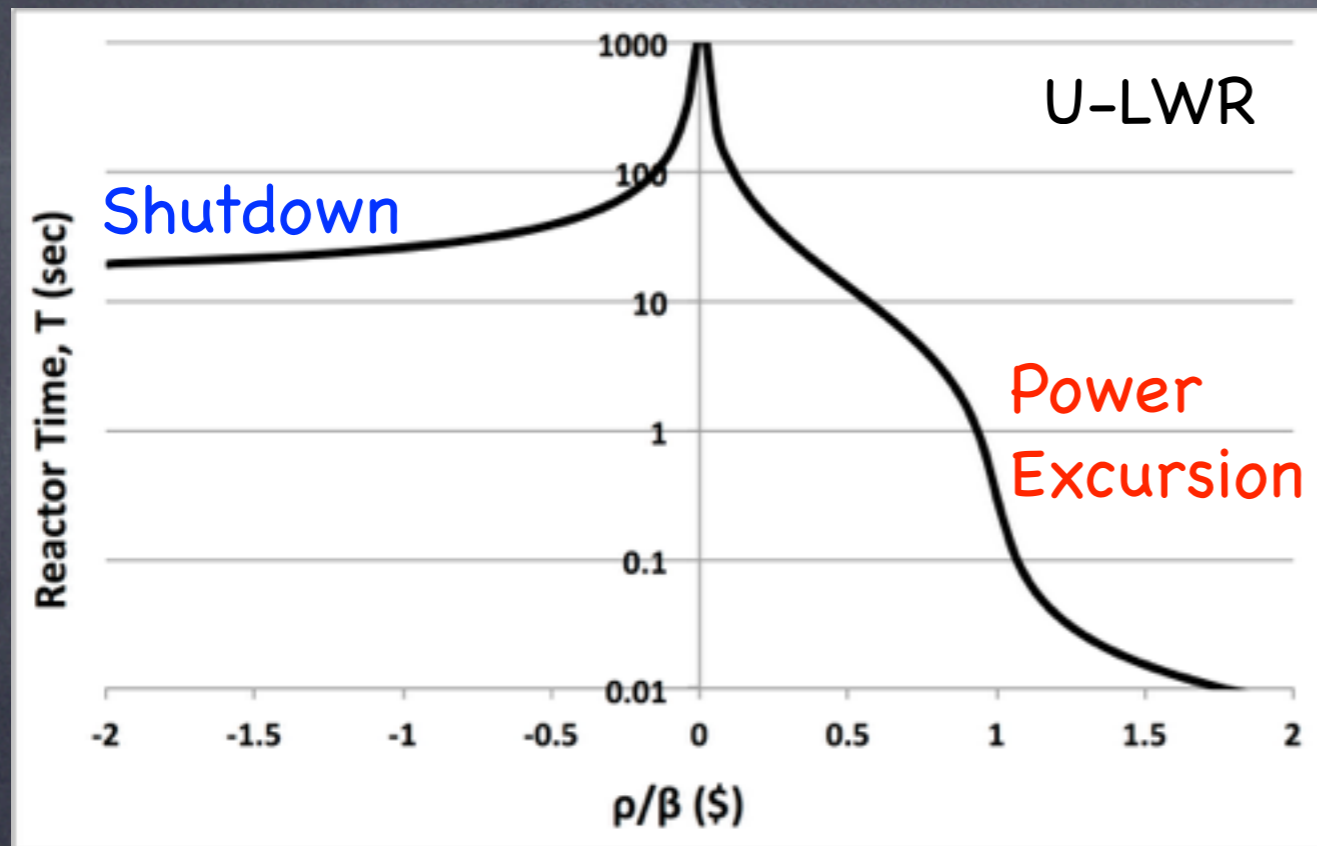

- $\beta$  is delayed fraction
- $\rho \approx (\text{Gen } N+1 / \text{Gen } N) - 1$ , including all of the neutrons
- $\rho/\beta$  is measured in \$ (!)
- You really want to stay far below \$1.00

- The Chernobyl reactor went “prompt critical” and reached at least 10x its normal operating power.
- Fusion systems have no equivalent of prompt criticality.

# Safety - Meltdown: TMI & Fukushima

- The fission reaction turns off when the chain reaction is extinguished, but radioactive decay continues to produce heat.

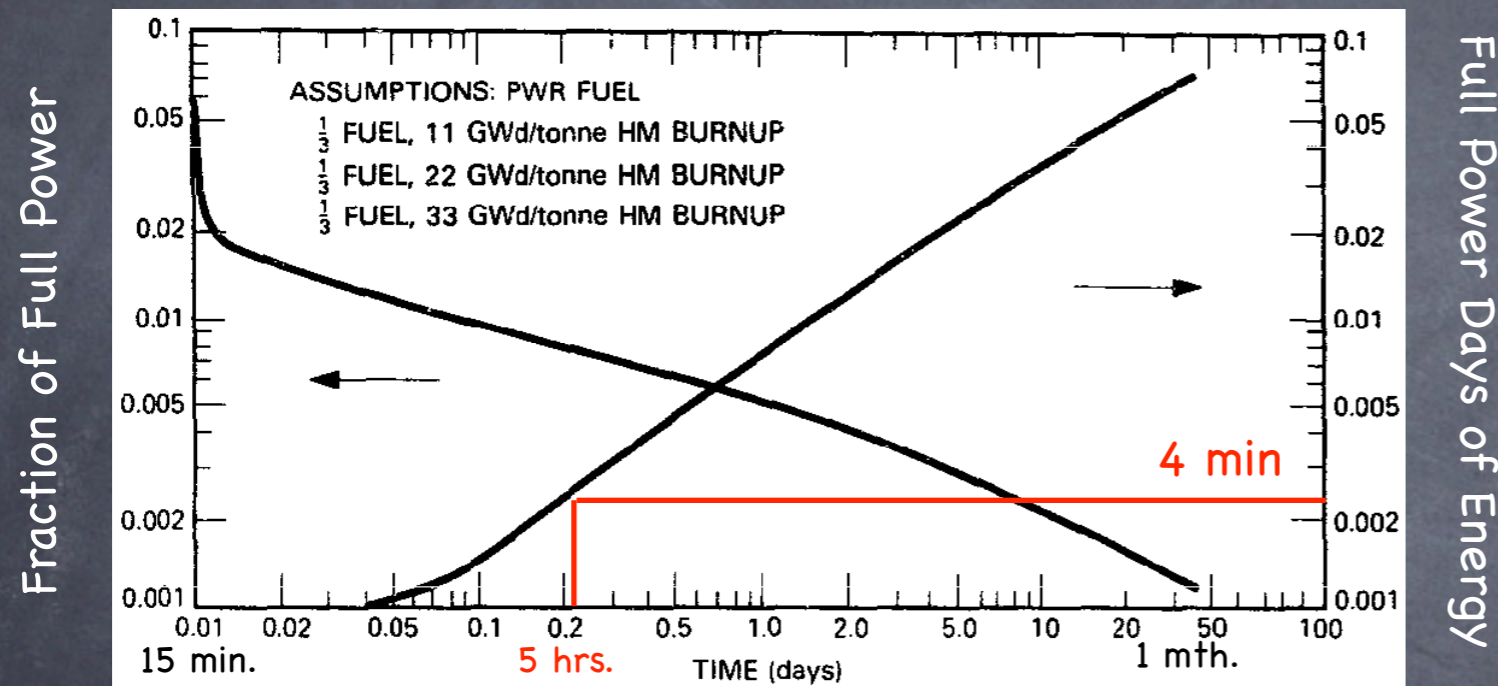

Light Water Reactors have about 5 hours to meltdown with no flow of cooling water.

- It was the failure to remove this decay heat that resulted in the core meltdowns at Three Mile Island and Fukushima
- There isn't major decay heat in a fusion system.

# Waste

- The U.S. and most other countries exclusively use a “once-through” fuel cycle:
  - Mine, enrich, burn, store, (bury).
  - Waste carries risk of dirty bombs, Pu usable in weapons
    - Stored spent fuel is self-protecting for  $\approx 100$  years



- Leave fuel rods in cooling ponds for  $\approx 5$  yrs
- Transfer to dry casks
- 2 casks hold 1 year of fuel
- What about the long run?  
Radiotoxicity is very long-lived.
- Fast reactor waste has little Pu and minor actinides, but still long-lived fission products.

- Waste from fusion is much less long-lived.

# Radioactivity from Fusion is Short-Lived

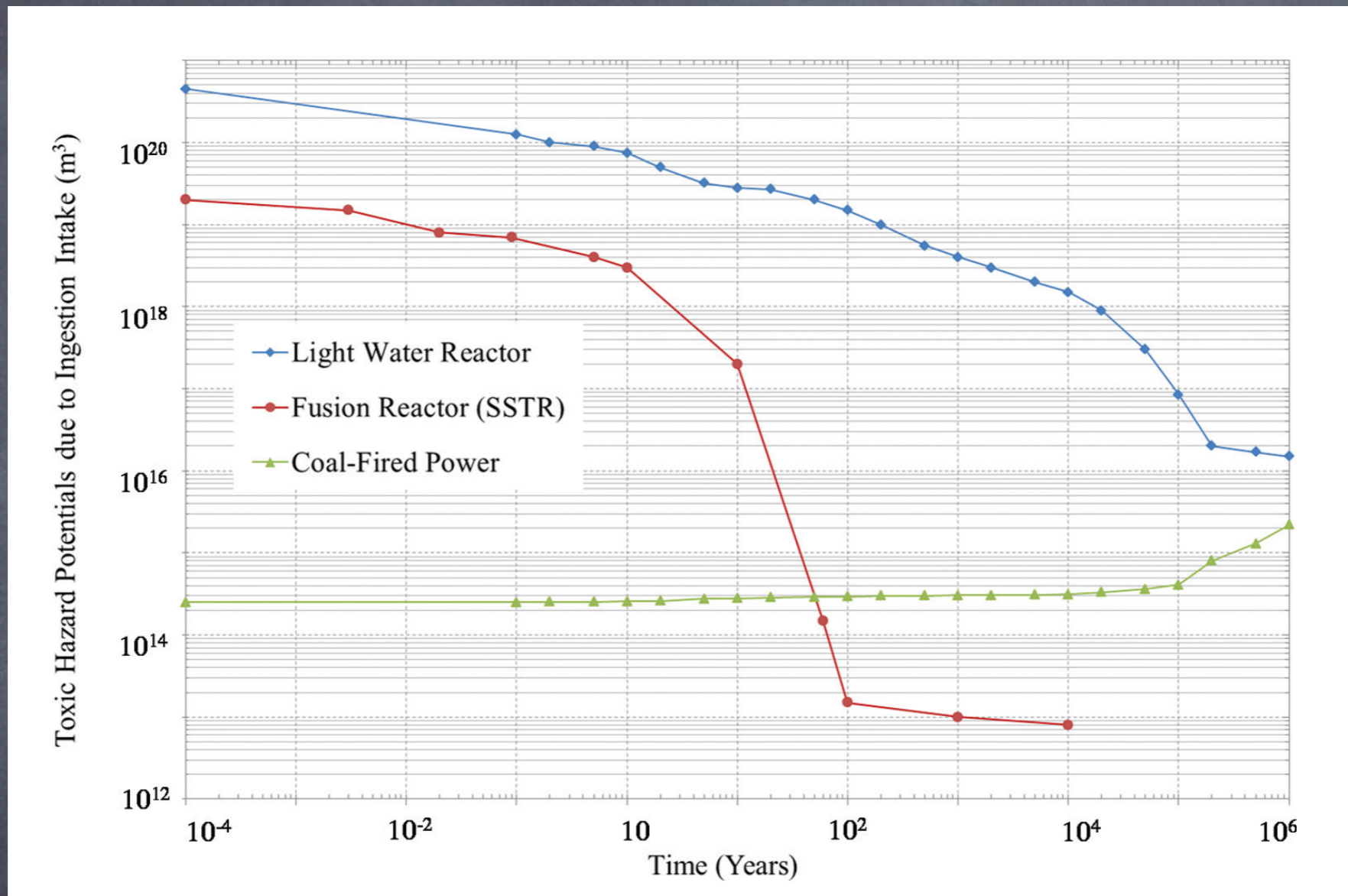

Biological Hazard Potential measured by how much water is needed to dilute all the materials to regulated safe drinking levels.

Fusion should require neither local evacuation plans nor geological storage of radioactive waste.

# Centrifuges Make Proliferation Easier



- A facility sized for 1 power plant can make material for  $\sim 75$  bombs/yr, starting from 4% enriched.

# Two Cycles Sustain DT Fusion

$T \sim 14 \text{ keV}$   
 $\sim 160 \text{ M K}$



heat

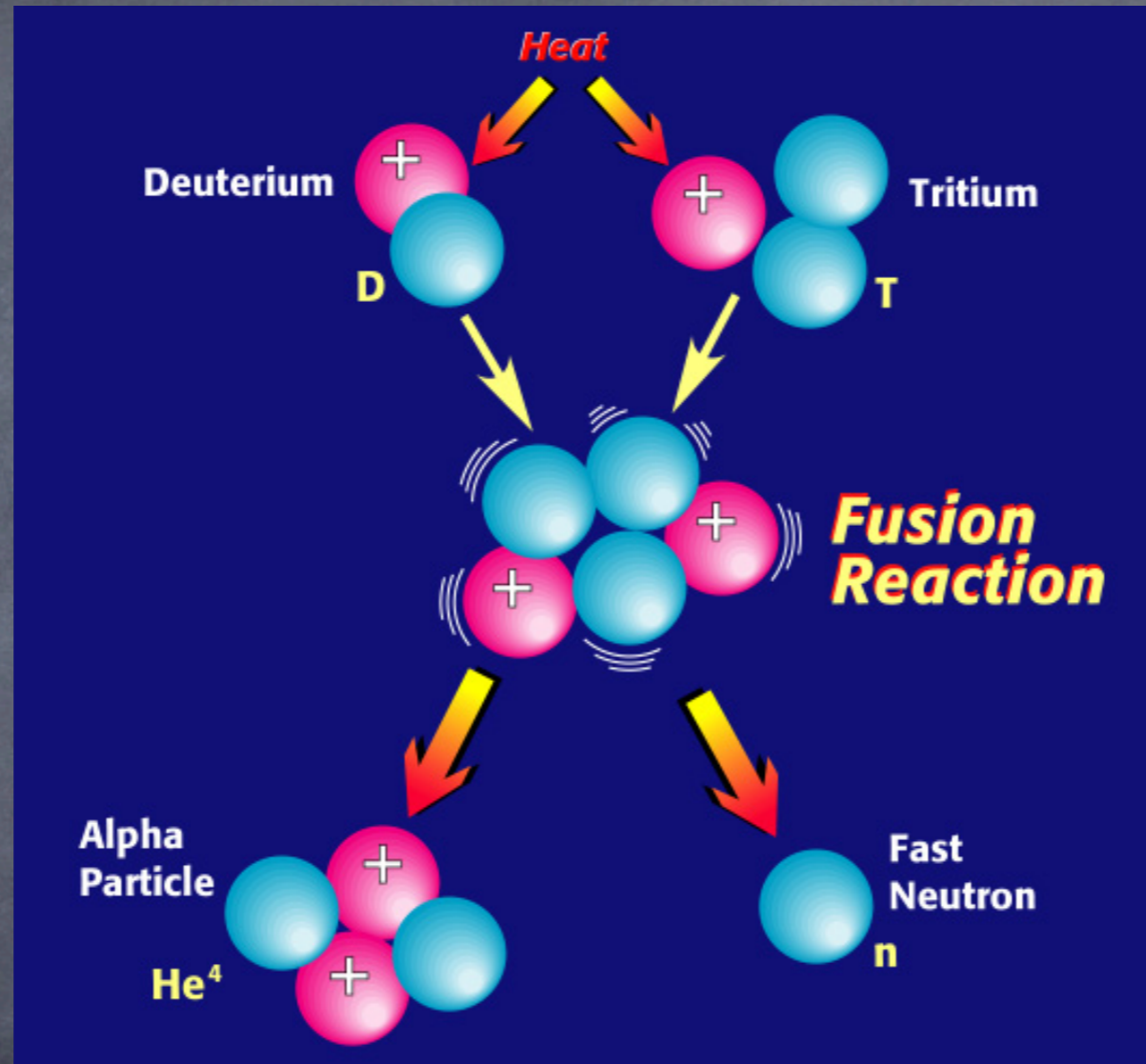

$\sim 400 \text{ g/day}$

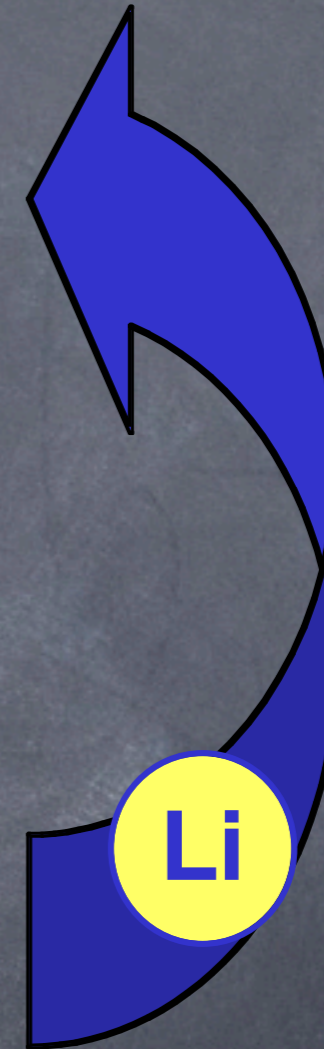

tritium



Fuel is plentiful & cheap D &  ${}^6\text{Li}$



# Fusion Requires very High Temperatures because of Electrostatic Repulsion of Nuclei

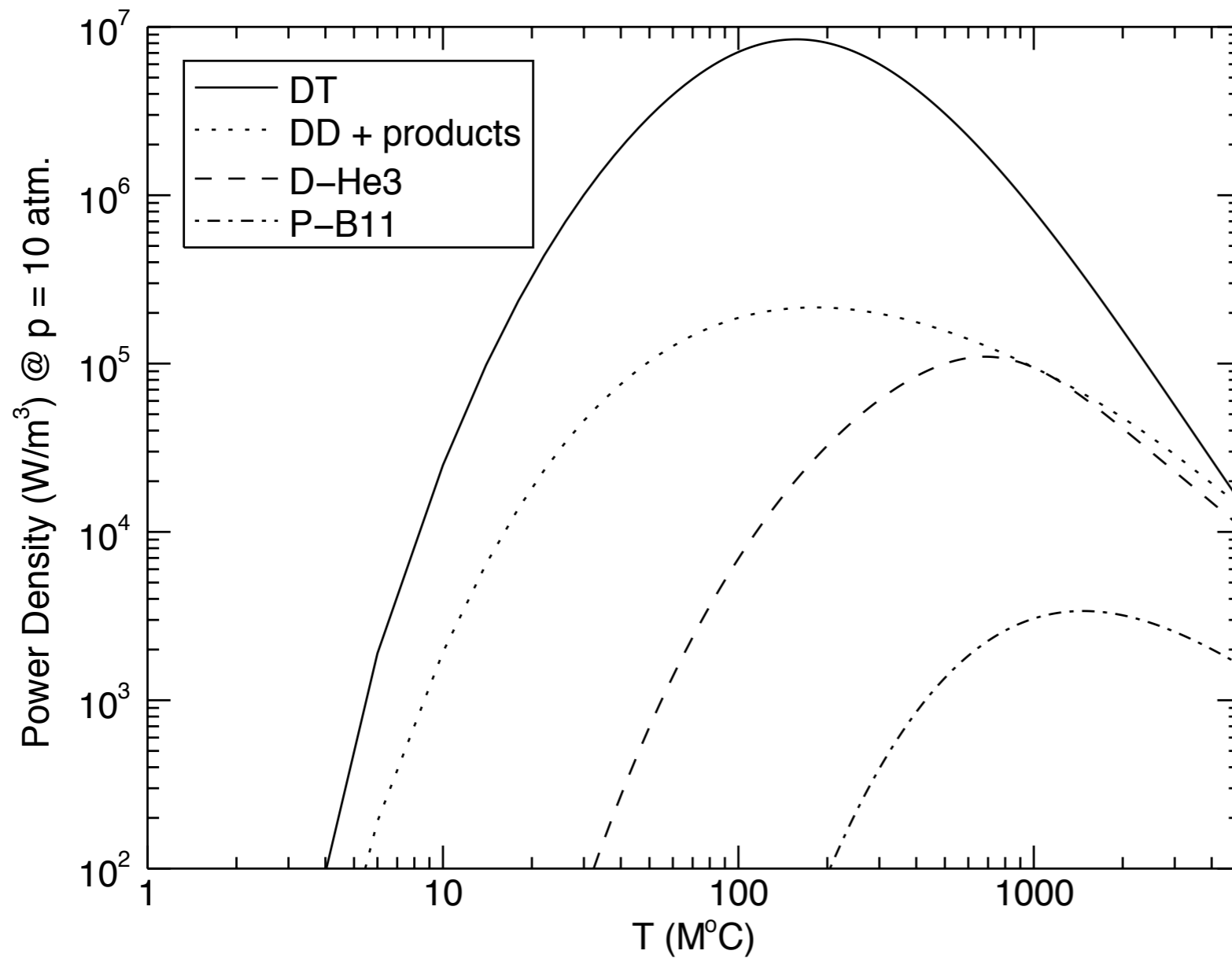

$\propto$  power density

= 1/5 fusion power density

$\approx 1.7 \cdot 10^6 \text{ W/m}^3$

Fuel energy density

=  $(3/2)nkT = (3/2)p$

= 15 atm  $\approx 1.5 \cdot 10^6 \text{ J/m}^3$

Need to "confine" power

for  $\sim 1 \text{ sec}$  for DT

At very (!) high T.

Confinement time

$\equiv \text{energy} \div \text{power}$

1 eV = 11,600 K, 10 keV = 116M K

# Fusion Fuel can be Confined Three Ways

Plasma  $\equiv$  ionized gas, occurs at  $T > 10,000$  K

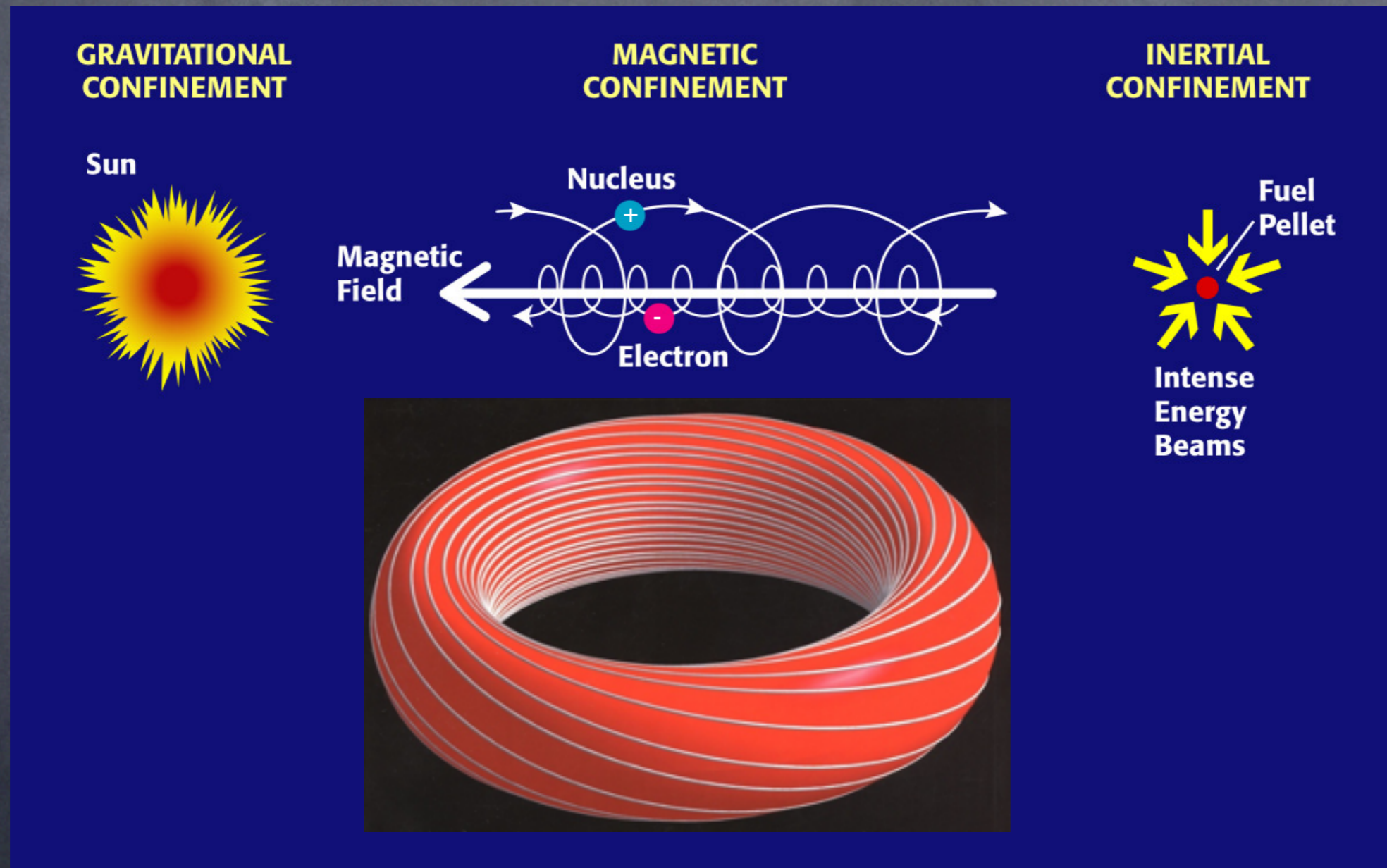

# First Issue is Macroscopic Stability

---

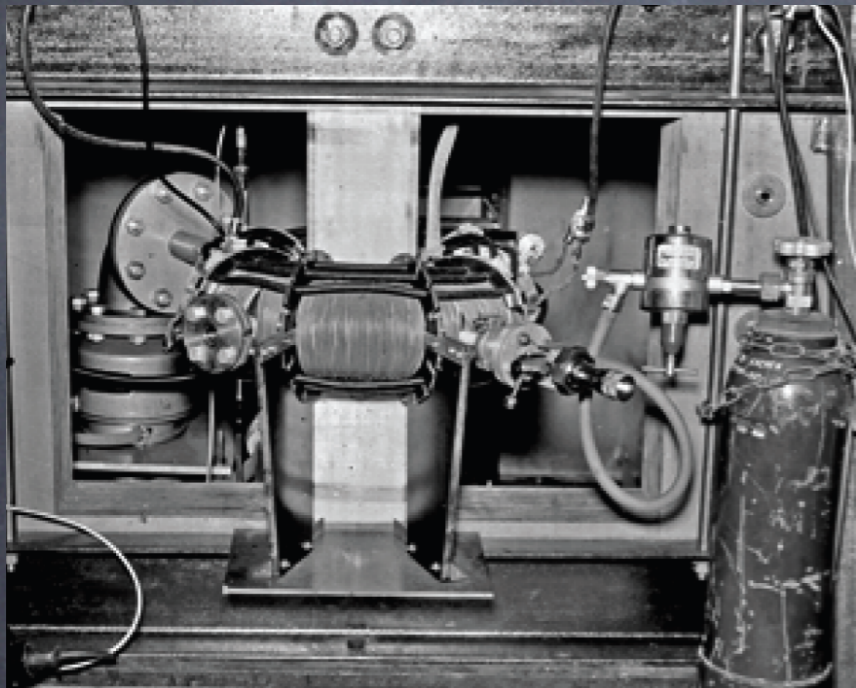

1957

First Experiments

“Perhapsatron” @LANL

Tore itself apart in  $\mu$ secs

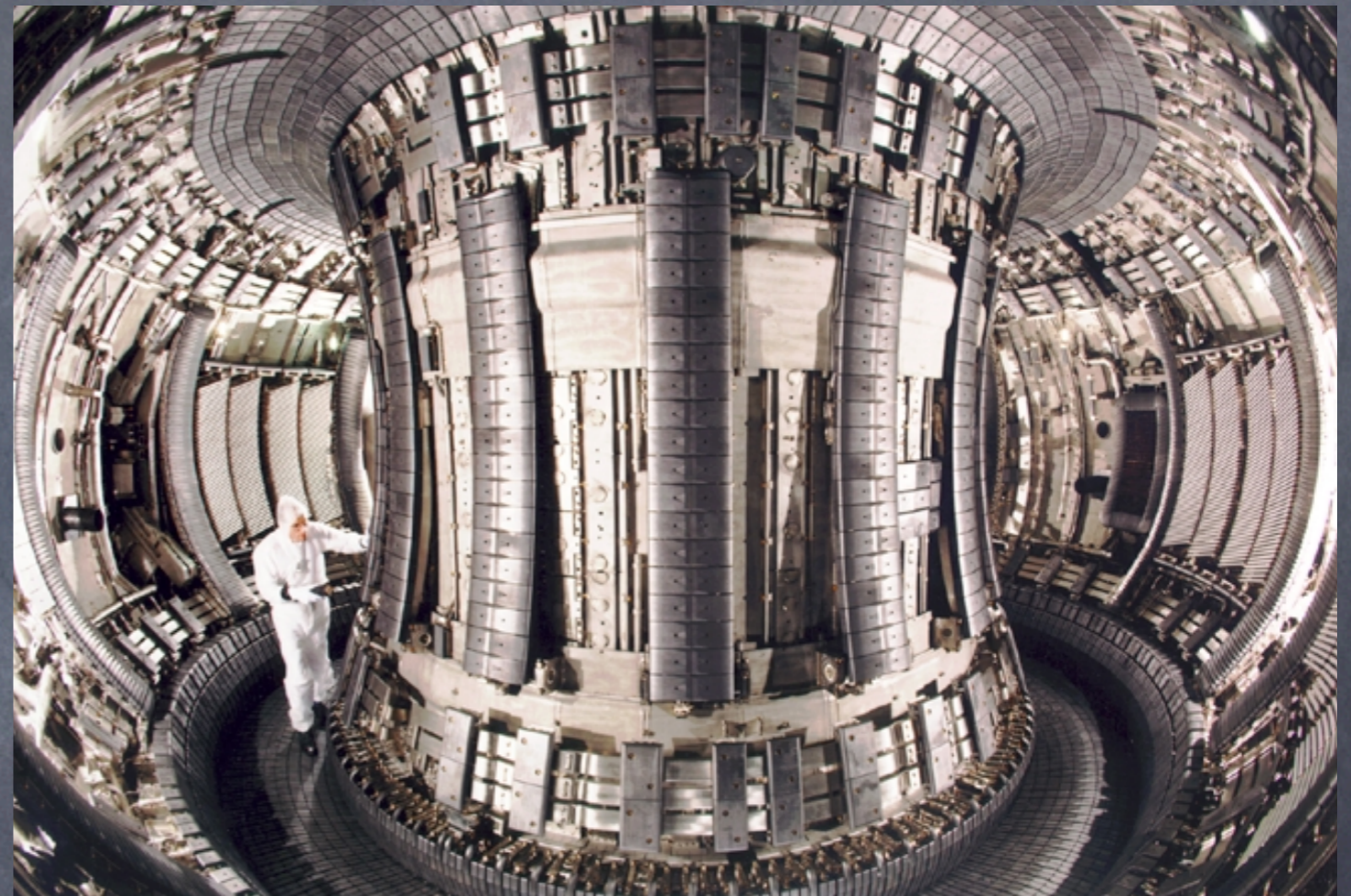

Joint European Torus

near Oxford, UK

Runs stably for 20 secs

# Next Issue is Confinement

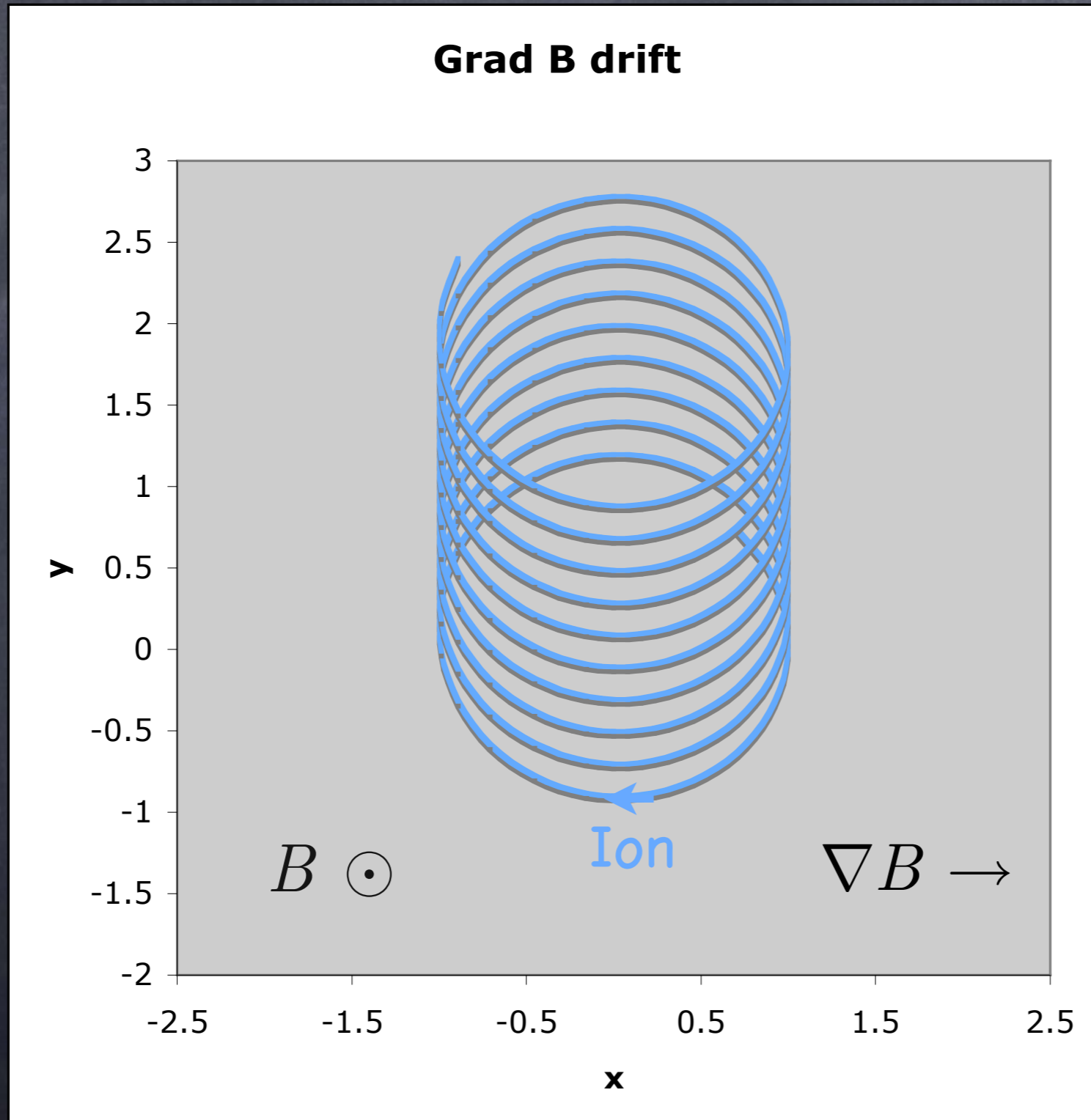

# Magnetic Twist (= Transform) Confines Orbits

$$B \propto 1/R$$

$$q \equiv \frac{\text{long-way transits}}{\text{short-way transits}}$$

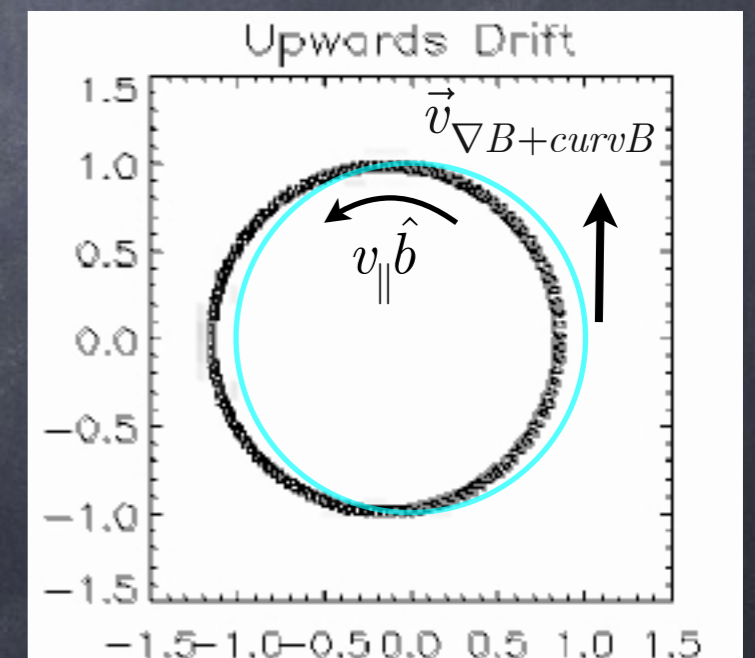
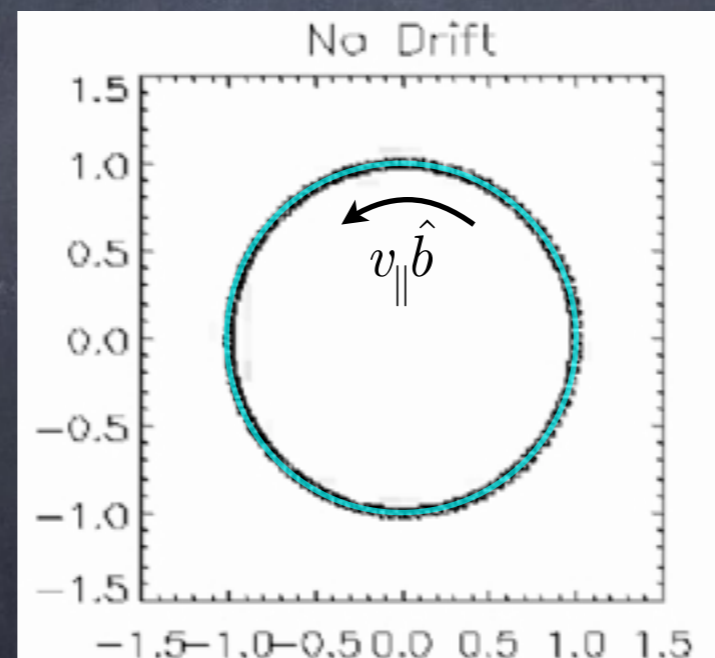
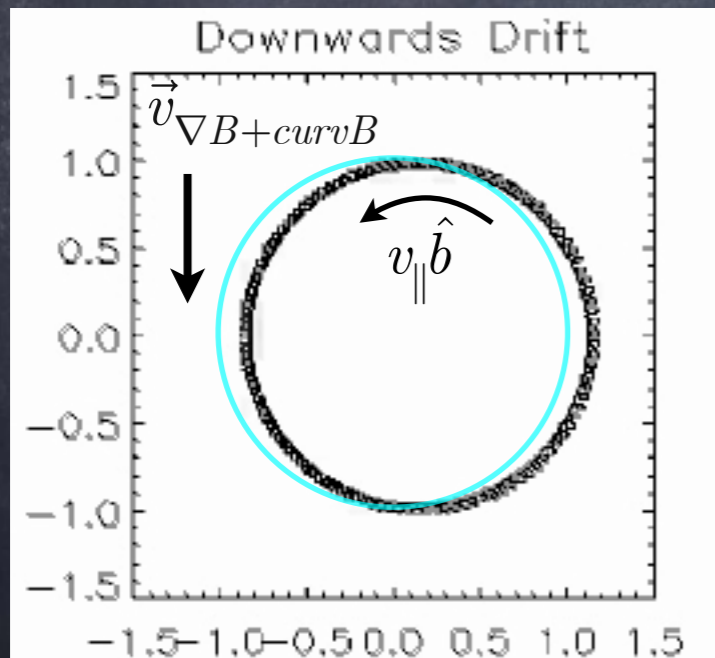
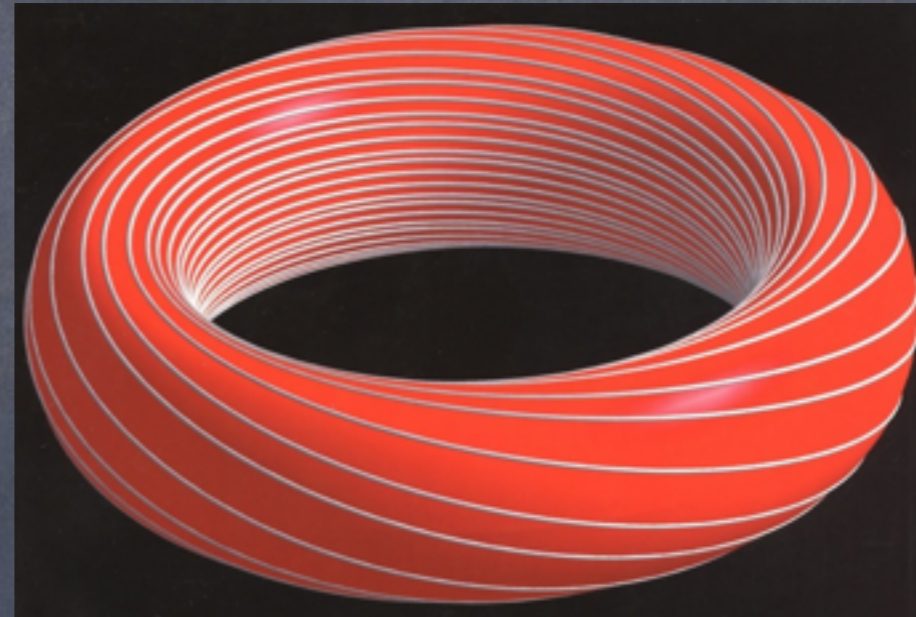

— Magnetic field

$$\delta r \sim \pm q r_L \cos \theta$$

# Concept for a Tokamak Fusion Pilot Plant

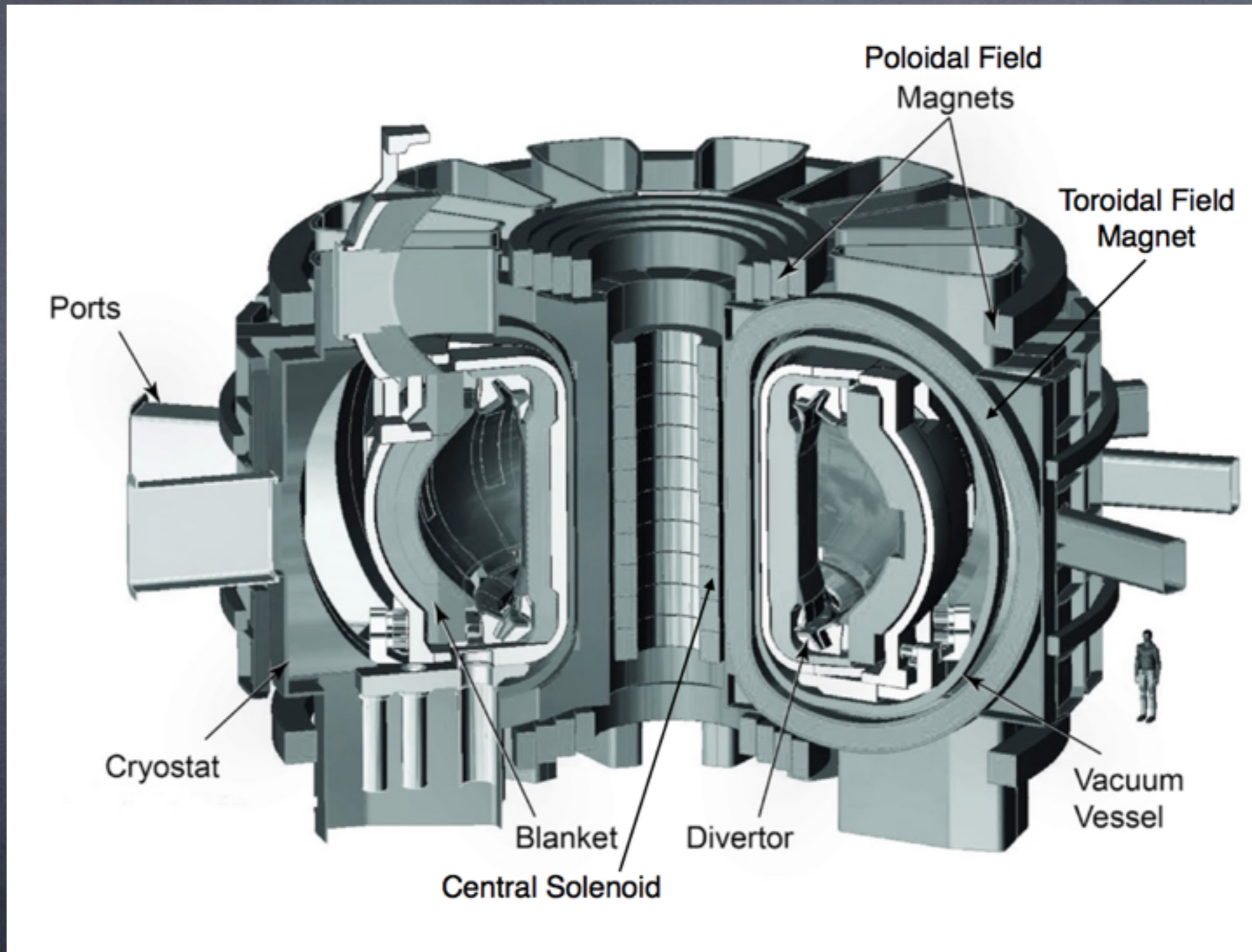

Gets magnetic twist with plasma current

# Stellarators Get Twist Differently

---

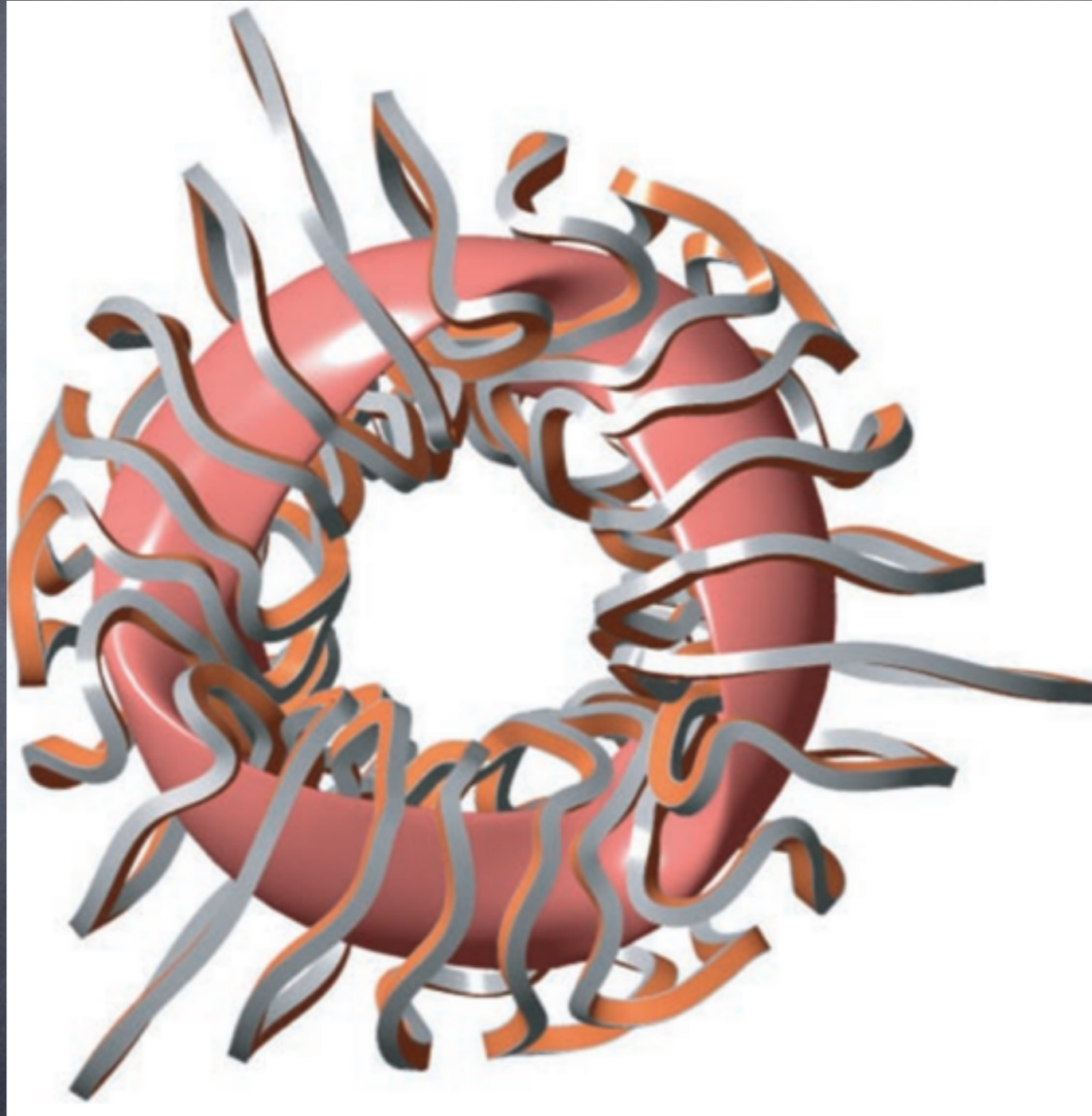

The twisting plasma "pulls" the field lines with it.

# Fusion Research is International

USA, Princeton: NSTX-U  
low aspect ratio tokamak



EU, Germany: W7X  
superconducting stellarator

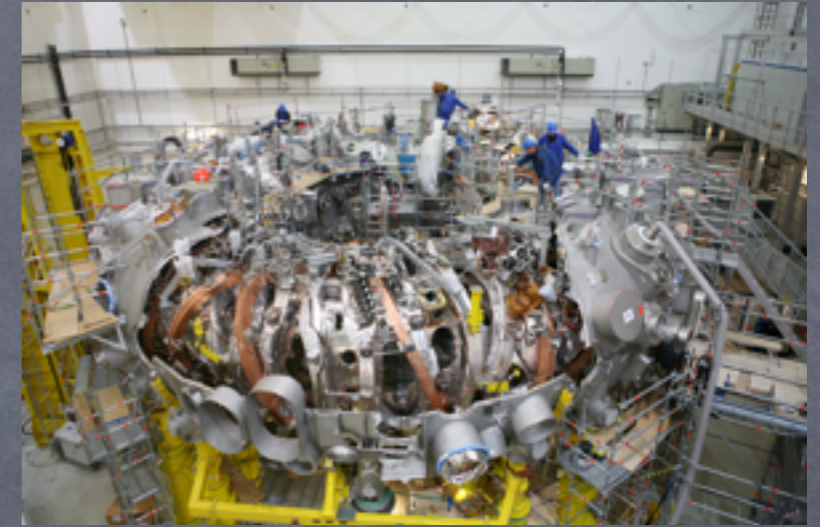

EU, Germany: ASDEX-U  
medium-size tokamak

USA, San Diego: DIII-D  
medium-size tokamak



EU, Great Britain: JET  
large tokamak

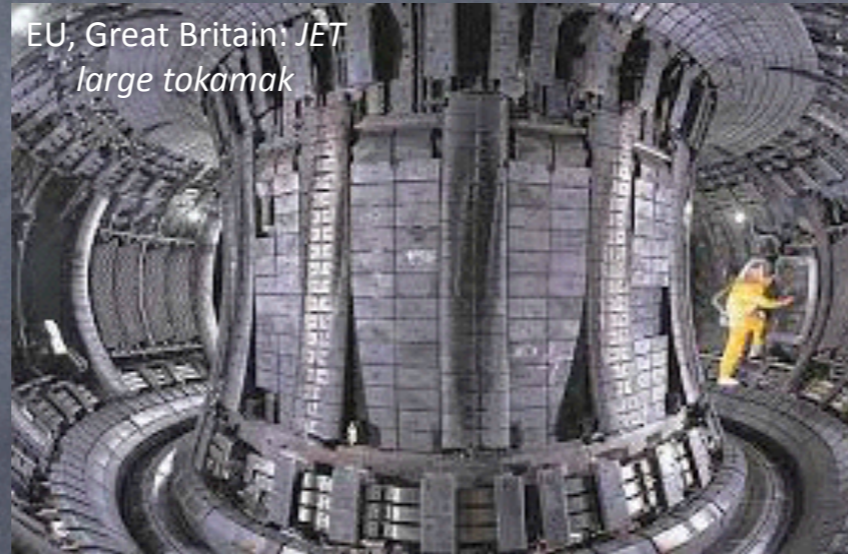

Japan: LHD  
superconducting stellarator



China: EAST  
superconducting tokamak



Korea: KSTAR  
superconducting tokamak

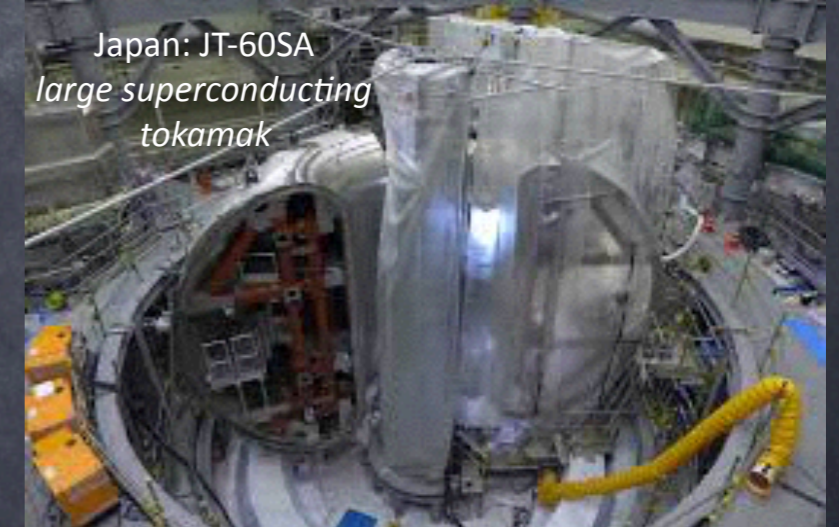

Japan: JT-60SA  
large superconducting  
tokamak



# The Plasma Energy is due to a Balance Between Heating and Losses

---

- Local power density balance (in the core) for steady operation

$$\frac{d}{dt}U_{th} = \frac{3}{2} \frac{d}{dt} \left( n_e + \sum_i n_i \right) T = 0 = n_D n_T \langle \sigma v \rangle_{DT} E_\alpha + p_{aux} - \frac{\frac{3}{2} \left( n_e + \sum_i n_i \right) T}{\tau_E^{transport}} - p_{rad,core}$$

$T$  and  $E_\alpha$  are in Joules,  $U$  is energy density, Joules/m<sup>3</sup>,  $p$  is power density, Watts/m<sup>3</sup>

- heating is in the core and core E-M radiation short-circuits magnetic confinement of heat.
- Here we assume 100% efficiency of  $\alpha$  particle heating.

# Plasma Gain, $Q_p$ , Depends on $nT \tau_E^{\text{transport}} (1 - f_{\text{rad,core}})$

$$P_a + P_{\text{aux}} = P_{\text{loss}} \equiv U_{\text{th}} / \tau_E^{\text{transport}} + P_{\text{rad,core}}; \quad f_{\text{rad,core}} \equiv P_{\text{rad,core}} / P_{\text{loss}}$$

$$P_{\text{loss}} - P_{\text{rad,core}} = U_{\text{th}} / \tau_E^{\text{transport}} = P_{\text{loss}} (1 - f_{\text{rad,core}})$$

$$P_{\text{loss}} = \frac{\frac{3}{2} \left( n_e + \sum_i n_i \right) T}{\tau_E^{\text{transport}} (1 - f_{\text{rad,core}})}$$

$$f_\alpha \equiv \frac{P_\alpha}{P_{\text{loss}}} = \frac{n_D n_T T^2 \left( \frac{\langle \sigma v \rangle_{DT}}{T^2} \right) E_\alpha}{\frac{\frac{3}{2} \left( n_e + \sum_i n_i \right) T}{\tau_E^{\text{transport}} (1 - f_{\text{rad,core}})}}$$

$$\propto nT \tau_E^{\text{transport}} (1 - f_{\text{rad,core}})$$

Fusion "triple product"

Looking at the whole plasma:

$$Q_p \equiv \frac{5P_\alpha}{P_{\text{aux}}} = \frac{5P_\alpha}{P_{\text{loss}} - P_\alpha} = \frac{5F_\alpha}{1 - F_\alpha} \quad \text{takes off as } F_\alpha \rightarrow 1$$

- Q<sub>p</sub> = 10 in ITER has T<sub>i0</sub> ≈ 20 keV, n<sub>e0</sub> ≈ 10<sup>20</sup>/m<sup>3</sup>, τ<sub>E</sub> ≈ 4sec;  
n<sub>e0</sub>T<sub>i0</sub>τ<sub>E</sub> ≈ 8 10<sup>21</sup> keV sec / m<sup>3</sup>

# Fusion "Triple Product" has Grown Dramatically

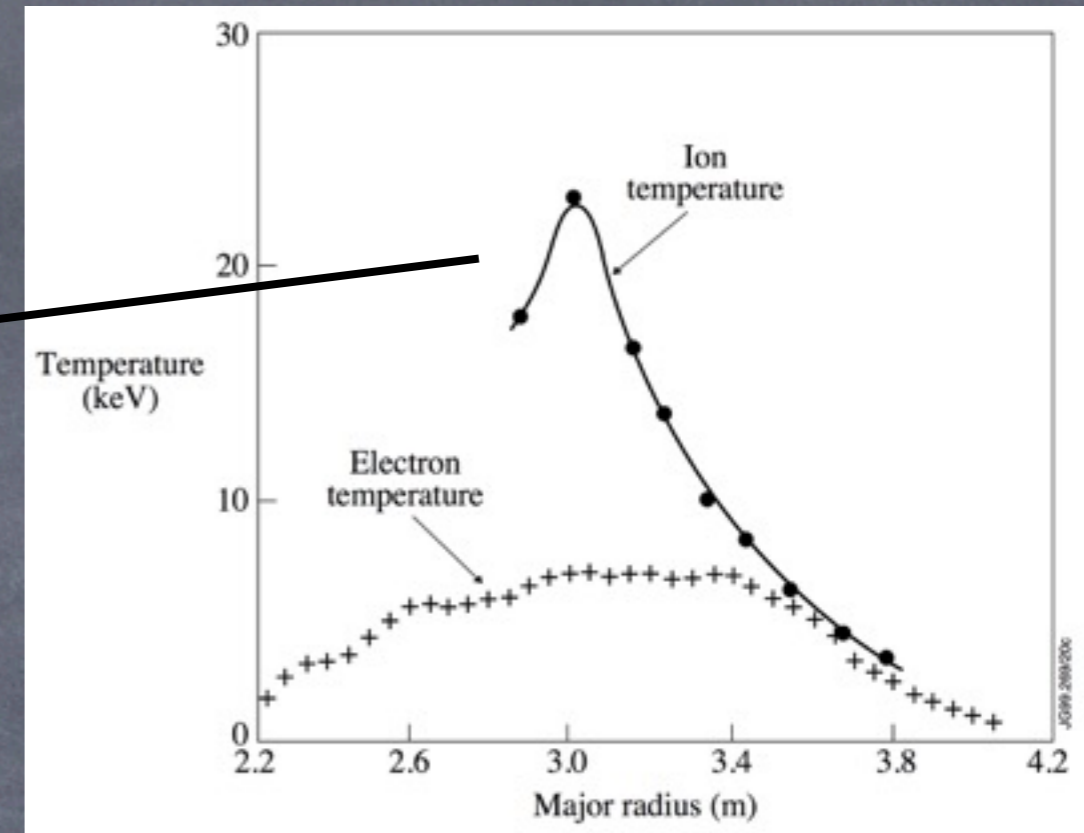
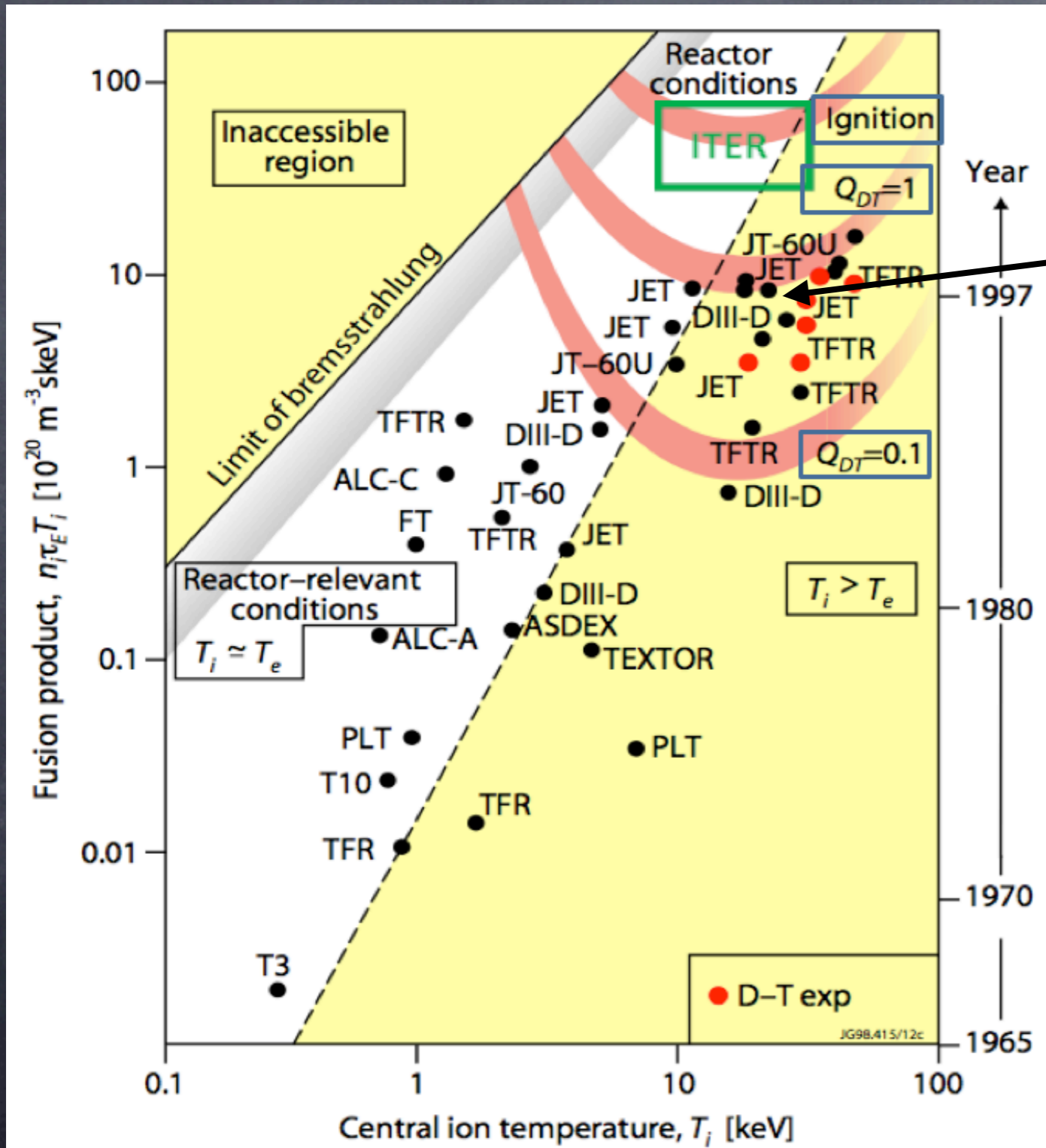

We should be able to attain self-sustained plasmas.

# Confinement is Predictable

Energy Confinement Time

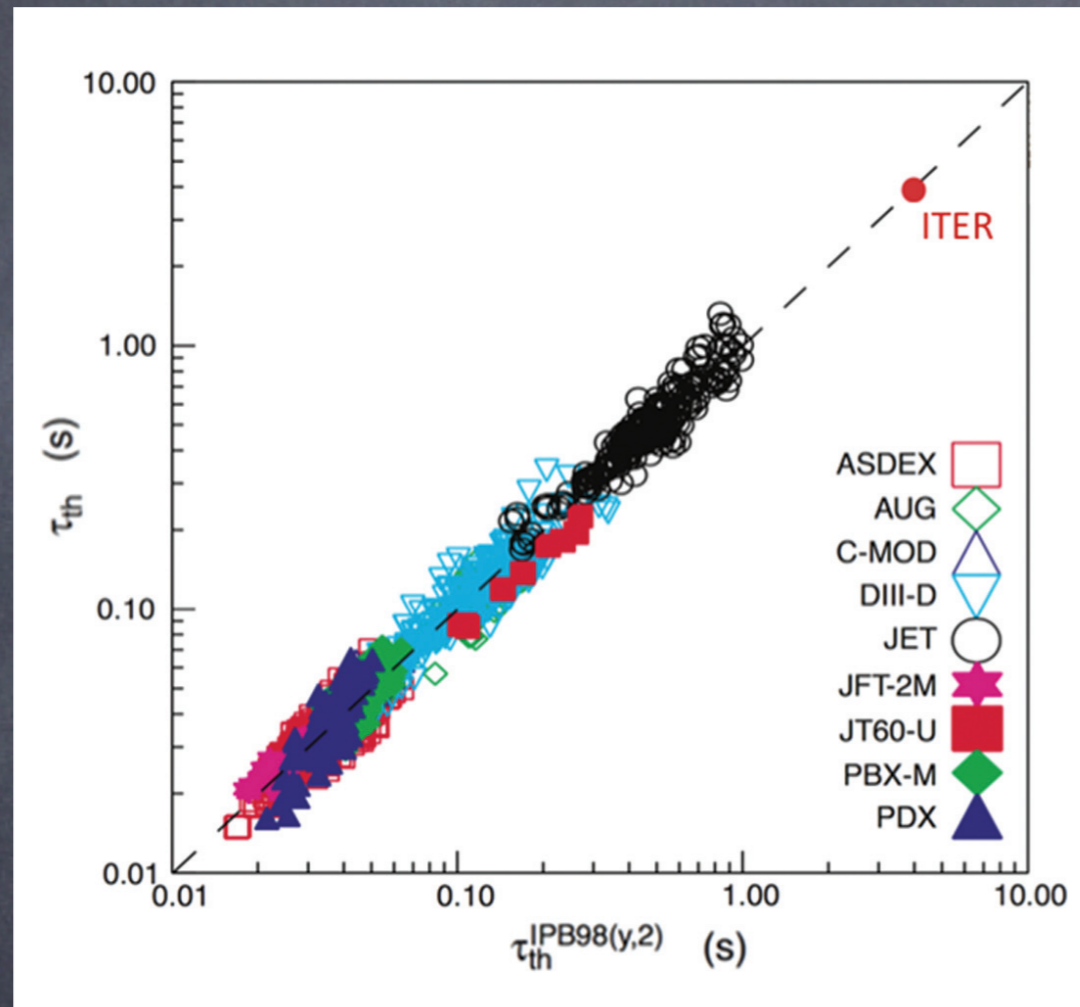

Regression Fit

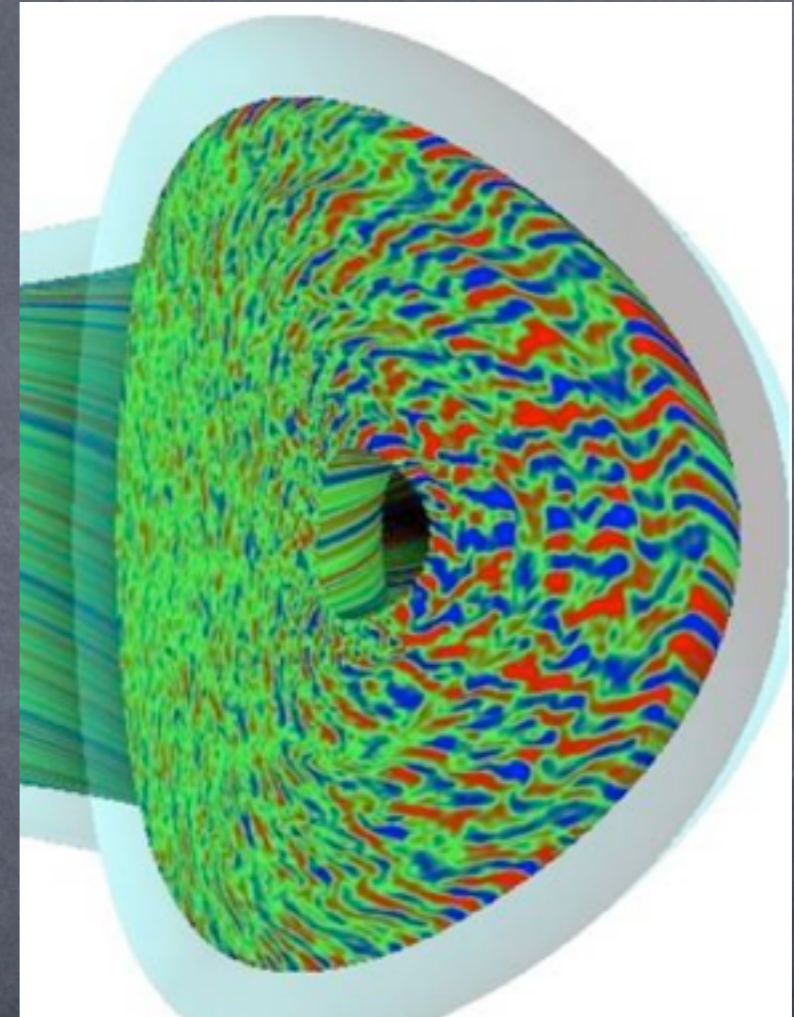

Turbulence  
Simulation

... but there can always be surprises...

# International Thermonuclear Experimental Reactor

---

An Agreement to Construct ITER was Signed in 2006  
China, Europe, India, Japan, Russia, South Korea, U.S.  
over 1/2 of the world's population

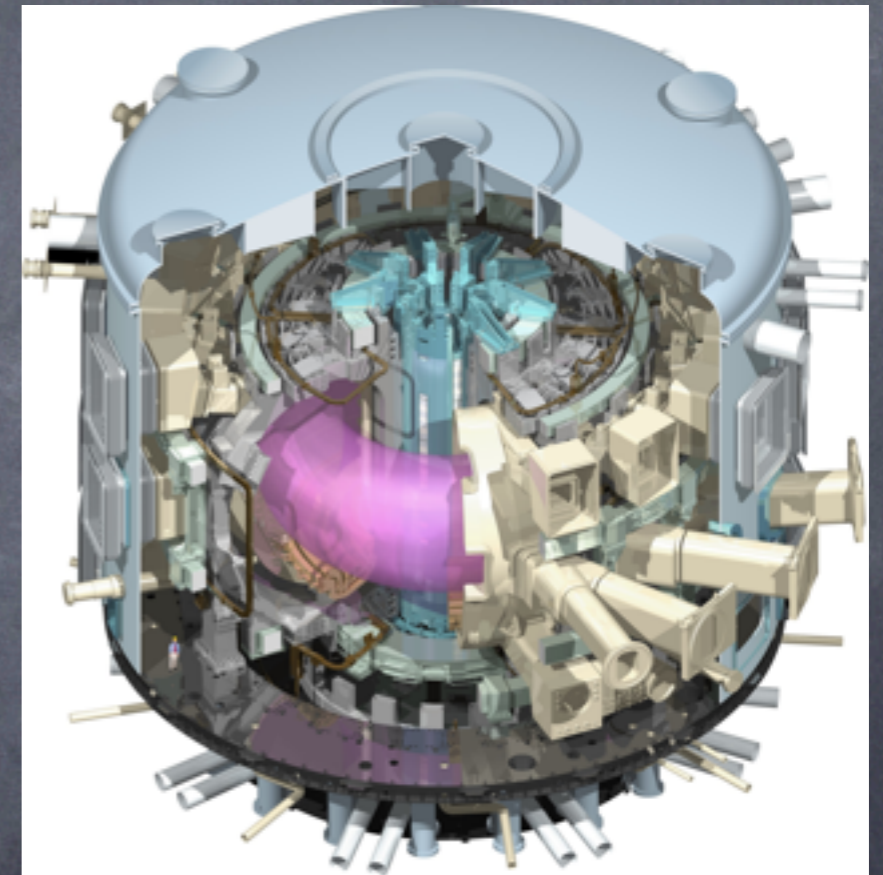

- Europe pays 5/11 – spending 1/5 of this in Japanese industry (!).
- Europe pays for one-half of a set of additional fusion R&D facilities – located in Japan, valued at 16% of ITER.
- Each of the other six participants (including U.S.) pays 1/11.

# ITER Construction is Underway

Aerial View



Tokamak Building



Coil Winding Facility



Assembly Hall, ITER STAC

# Why Use Fusion for Energy?

---

- Worldwide, very long term availability of low cost fuel.
- Fusion does not have fission's key issues:
  - No possibility of prompt criticality or meltdown.
  - Short-lived radioactive waste.
  - Low risk of nuclear proliferation.
- Steady power source** that can be located near markets.  
(c.f., wind, solar; order unity backup power or storage, **at scale**)
- Little land use**  
(c.f., biomass competition with agriculture, **at scale**)
- No need to bury carbon dioxide**  
(c.f., biomass, coal, gas require immense CO<sub>2</sub> storage, **at scale**)

Cost?

# Electricity Needs to Double > 2050

## Electrical Power (EJ/year)

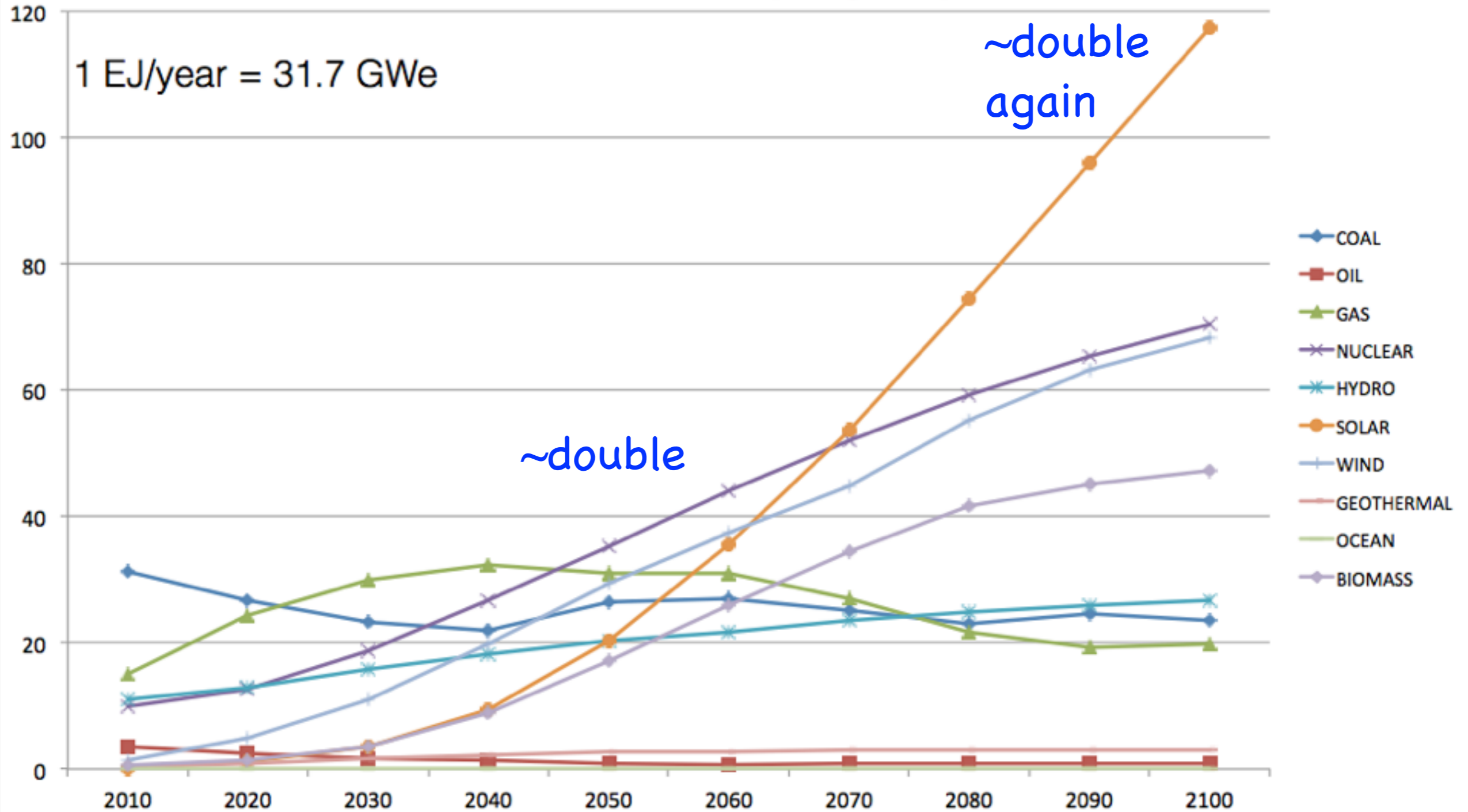



# Science & Technology Challenges Remain

- A lot of progress has been made in:
  - Macroscopic stability
  - Plasma heating and current drive
  - Energy confinement
- An area of opportunity:
  - High temperature superconducting magnets

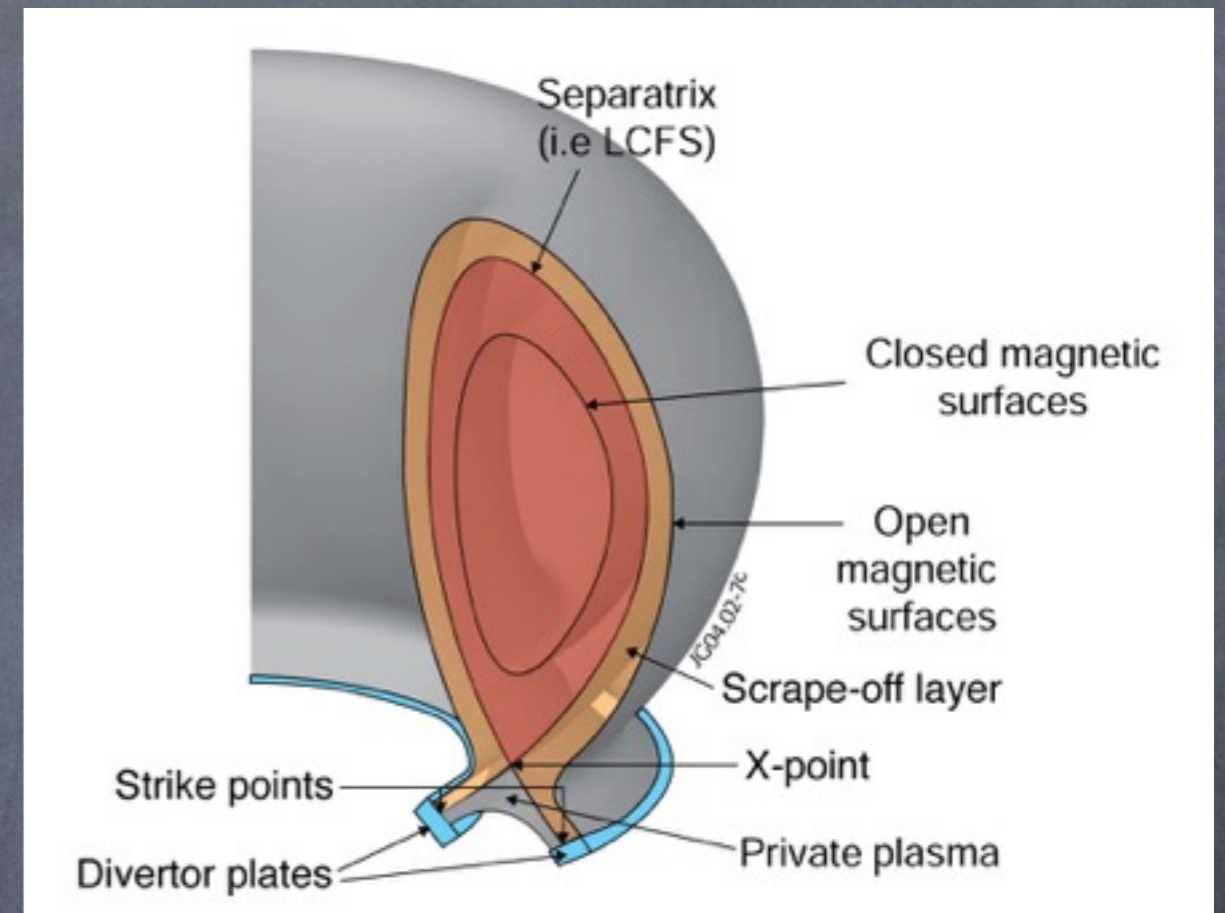

- The biggest risks:
  - Power efflux
  - Materials and blanket